

SRB/SRE



PROJECT	
QUOTE	
PREPARED BY	
DATE	

DESCRIPTION

The Small Round Pole was designed with aesthetics in mind. Our slimmest pole, the SRB/SRE is used in many applications, from commercial to residential, and for general area lighting. Our standard choice, the Small Round Pole retains the round, tapered feature of DesignPole, the optimal form for wind loads.

ORDERING INFORMATION

Ordering Example: SRB-12-SG-DG-T1

MODEL	HEIGHT	POLE FINISH	STEEL PART FINISH
SRB	8' to 24'	WG : White Granite	DG : Dark Grey (Glossiness : 20%)
SRE		RGS : Roof Grey S SG : Stained Glass BL : Brown Light BD : Brown Dark CM : Choco Mint	LG : Light Grey (Glossiness : 50%) MG : Metallic Grey (Glossiness : 92%)

TENON	ARM	OPTIONS
<p>T1 : 2-3/8" O.D. x 4" T2 : 2-3/8" O.D. x 6" T3 : 2-7/8" O.D. x 3" T5 : Other (Contact Manufacturer)</p> <p>T1/T2 T3</p>	<p>* DPSR available in double-sided form * Adjustable arm length</p> <p>DPSR</p>	<p>BC : Base Cover</p> <ul style="list-style-type: none"> BOTTOM : 14-1/8" O.D. HOLE : 7-7/8" O.D. ~ 5-11/16" O.D. HEIGHT : 6-11/16"

NOTES :

1. SRB : Base Plate Type (Anchor Base) / SRE : Embedded Type (Direct Buried)
2. In the case of SRE, the height listed is from ground level and does not include the embedded depth.
3. For custom tenons/arms, please consult manufacturer before ordering.

Small Round Pole SPECIFICATION

Base Plate Type

PRODUCT NUMBER	POLE HEIGHT "A"	BASE O.D.	ANCHOR BOLT	BOLT CIRCLE	BASE PLATE "B"	ULTIMATE G.L. MOMENT [FT. LBS.]	WEIGHT [LBS.]	MAXIMUM EPA/MPH[SQ FT]*					
								80	90	100	110	120	130
SRB-10	10'-0 3/4"	5 9/16"	3/4" X 24" X 4	10"	9"	7567	165	13.0	11.0	8.0	6.0	4.0	3.0
SRB-12	12'-0 3/4"	5 7/8"	3/4" X 24" X 4	10"	9"	8566	209	12.0	11.0	8.0	5.0	3.0	2.0
SRB-14	14'-0 3/4"	6 3/16"	3/4" X 24" X 4	10"	9"	9632	256	11.0	9.0	6.0	4.0	3.0	1.5
SRB-16	16'-0 3/4"	6 1/2"	3/4" X 24" X 4	10"	9"	10740	307	10.0	8.0	4.5	3.0	1.5	1.0
SRB-18	18'-0 3/4"	6 13/16"	3/4" X 24" X 4	10"	9"	13193	360	11.0	9.0	4.5	3.0	1.0	0.5
SRB-20	20'-0 3/4"	7 1/8"	3/4" X 24" X 4	10"	9"	14503	418	10.0	8.0	4.0	2.0	0.5	0.2
SRB-22	22'-0 3/4"	7 7/16"	3/4" X 24" X 4	10"	9"	15885	479	9.0	7.0	3.0	1.5	0.2	0.1
SRB-24	24'-0 3/4"	7 3/4"	3/4" X 24" X 4	10"	9"	17305	544	8.0	6.0	2.5	1.0	0.1	0.1

Embedded Type

PRODUCT NUMBER	POLE HEIGHT "A"	BASE O.D.	OVERALL LENGTH "OL"	EMBEDDED DEPTH "B"	ULTIMATE G.L. MOMENT [FT. LBS.]	WEIGHT [LBS.]	MAXIMUM EPA/MPH[SQ FT]*					
							80	90	100	110	120	130
SRE-8	8'-0 3/4"	5 3/4"	11'-3 11/16"	3'-3"	8181	137	9.5	8.5	7.6	7.9	9.1	7.2
SRE-10	10'-0 3/4"	5 7/8"	13'-8 5/16"	3'-7 1/2"	8582	174	9.3	8.3	7.3	7.5	8.8	7.8
SRE-12	12'-0 3/4"	6"	16'-0 11/16"	4'	8999	213	9.8	8.7	7.7	7.8	8.9	8.0
SRE-14	14'-0 3/4"	6 1/2"	18'-3 11/16"	4'-3"	10755	269	12.1	10.8	9.4	9.3	10.6	9.6
SRE-16	16'-0 3/4"	6 3/4"	20'-6 11/16"	4'-6"	11686	318	13.0	11.5	10.0	9.9	11.0	10.0
SRE-18	18'-0 3/4"	7"	22'-10 9/16"	4'-9 3/4"	12651	370	13.8	12.2	10.5	10.2	11.2	10.2
SRE-20	20'-0 3/4"	7 1/4"	25'-0 11/16"	5'	13652	528	17.5	13.6	9.3	7.4	7.0	5.7

POLE SPECIFICATION

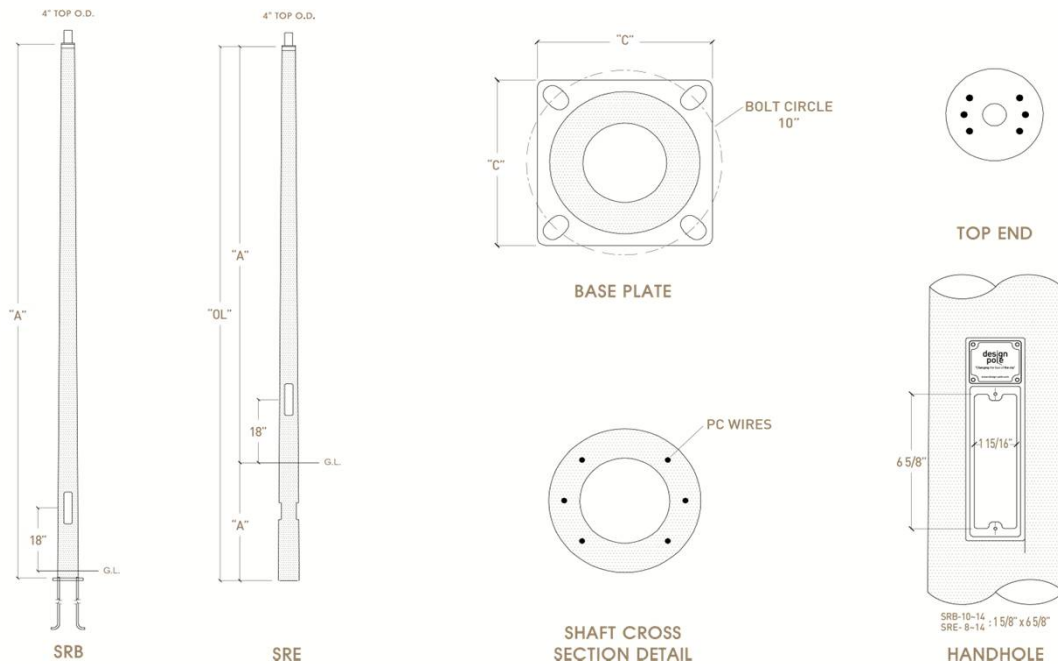

design pole

"Changing the face of the city"

3580 Wilshire Blvd., Suite 900-22 Los Angeles, CA 90010

Website_www.design-pole.com

Tel_(213)487-3036

POLE FINISH

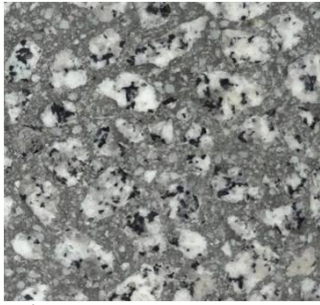

White Granite

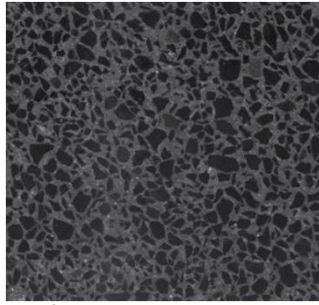

Roof Grey S



Stained Glass

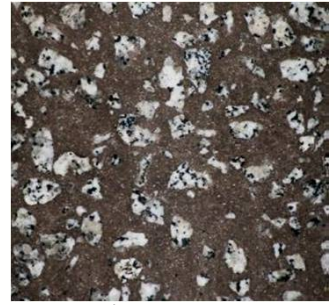

Brown Light

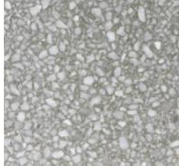

Wall Stone

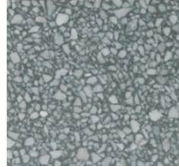

Candy Blue

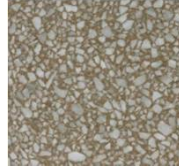

Fade Orange

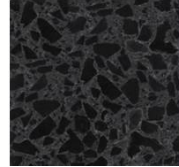

Roof Grey B

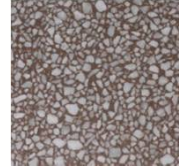

Passion Red

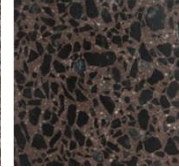

Brown Dark

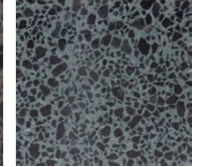

Choco Mint

STEEL FINISH



Dark Grey



Light Grey



Metallic Grey

FEATURES

1. Prestressed spun concrete makes DesignPole one of the strongest in the market.
2. The addition of natural stone aggregates, besides strengthening the concrete, makes for an aesthetically pleasing look.
3. This concrete is processed with our patented polishing technique that exposes a unique surface that resembles terrazzo.
4. DesignPole virtually eliminates maintenance costs. No need for painting or coating.
5. DesignPole can withstand any weather condition, such as heavy rain and wind, in any environment, such as the oceanfront or desert.
6. Customization available. Consult manufacturer.

design
pole

"Changing the face of the city"

3580 Wilshire Blvd., Suite 900-22 Los Angeles, CA 90010

Website www.design-pole.com

Tel_(213)487-3036